



Vx-Series User Guide

Vx50i

Vx150i

DOMINO

All rights reserved. No part of this publication may be reproduced, stored on a retrieval system, or transmitted in any form, or by any means, electronic, mechanical, photocopying, recording or otherwise, without the prior permission of Domino Printing Sciences plc.

Domino Printing Sciences plc. has a policy of continuous product improvement, the company therefore reserves the right to modify the specification contained in this document without notice.

© Domino Printing Sciences plc 2022.

For sales, service and inks please contact:

www.buydomino.com

www.domino-printing.com

Domino UK Limited

Trafalgar Way
Bar Hill
Cambridge CB23 8TU
United Kingdom
Tel: +44 (0)1954 782551
Fax: +44 (0)1954 782874
Email: enquiries@domino-uk.com

Domino North America

1290 Lakeside Drive
Gurnee IL.60031
U.S.A.
Tel: +1 847 244 2501
Fax: +1 847 244 1421

Amendment Record

Amendment	Date
All parts at Issue 1	June 2022
All parts at Issue 2	September 2022

PREFACE USER GUIDE

This document, Domino Part No. EPT065669, is the official authority for the installation, operation, maintenance and recycling of Domino Vx-Series Thermal Transfer Overprint units.

This document should be used to reinforce and complement any training program available with the product. It is not designed to replace any such training program.

This product manual is the source document for all translated versions. It is the "Original Instructions".

Domino will not accept any liability for damage to equipment or injury to personnel caused by unauthorized or improper use of the Thermal Transfer Overprint equipment.

Only engineers trained by Domino should carry out repairs, adjustments or in any other way alter settings or machine parts. Domino original parts shall always be used to ensure quality and performance.

Users of this equipment are warned that it is essential to read, understand and act according to the information given in Part 1: Health and Safety. This part of the document also specifies a set of symbols which are used elsewhere in the document to convey special warnings or requirements. It is, therefore, essential that users are also familiar with these symbols and act accordingly.

It is important to:

- Keep this document during the lifetime of the equipment.
- Pass this document on to any subsequent holder or user of the equipment.

GENERAL

This User Guide provides:

- A basic introduction of the Domino Vx-Series.
- Details of the user interface.
- Preventative maintenance procedures.
- Fault finding and diagnosis.

FCC Notice

This equipment has been tested and found to comply with the limits for a Class A digital device, pursuant to part 15 of the FCC Rules. These limits are designed to provide reasonable protection against harmful interference when the equipment is operated in a commercial environment. This equipment generates, uses, and can radiate radio frequency energy and, if not installed and used in accordance with the instruction manual, may cause harmful interference to radio communications. Operation of this equipment in a residential area is likely to cause harmful interference in which case the user will be required to correct the interference at his own expense.

Any changes or modifications not expressly approved by the manufacturer could void the user's authority to operate the equipment.

European EMC Statement

This product may cause interference if used in residential areas. Such use must be avoided unless the user takes special measures to reduce electromagnetic emissions to prevent interference to the reception of radio and television broadcasts.

Software Licensing

This product contains open source software components that are subject to the terms and conditions of the applicable open source licences. Those open source software components, the open source licences applicable to them, and, where required, copies of their source code, can be found at: <https://www.domino-printing.com/en-gb/legal-and-ip/open-source-licensing.aspx>

Intended Use

The Vx-Series is a range of industrial Thermal Transfer Overprint printers designed for coding and marking onto a variety of flexible film substrates and products. For specific details, please contact your local support office. Do not use it for any other purpose, unless authorised by Domino. If the equipment is used in a manner not specified by the manufacturer, the protection provided by the equipment may be impaired.

Each printer consists of:

- A Printer containing the printer's electronic control systems and ink ribbon.
- An optional User Interface consisting of a 7 inch touch screen.

Target Audience

This document provides product safety, installation, operation and maintenance information.

- Only a suitably trained and qualified person should install the printer.
- Domino recommends that all operators receive product training before operating the equipment.
- Only engineers trained and certified by Domino should carry out repairs.
- Genuine Domino parts should always be used to ensure quality, safety and performance.

CONTENTS

	page
Preface User Guide.	3
General.	3
Warnings, cautions and notes.	8
Specific Warnings.	10
Specific Cautions.	14
Consumables Information.	16
Electro-Static Discharge.	17
Product/Battery End of Life.	18
USA State of California Battery Statement.	18
Description.	19
Printer Types.	20
Specification.	21
Mechanical Installation.	23
Electrical Installation.	25
Start Up.	29
Statuses, Alerts and Fault Finding.	33
Install a Ribbon.	35
Cleaning.	41

PART 1 HEALTH AND SAFETY

WARNINGS, CAUTIONS AND NOTES

WARNING	
What is the hazard. Risk of personal injury.	
	A warning is used to alert the reader of hazards which may cause loss of life, physical injury or ill health.

CAUTION	
Possible hazard. Risk of damage to equipment.	
	A caution is used to alert the reader of possible hazards which may cause damage to equipment or the environment.

Note A note is used to alert the reader to important information

Symbols

The following symbols are used in this product manual to highlight specific warnings and cautions used in the procedure below the symbols.



Warning or Caution, read and comply with the warning or caution text to avoid physical injury, damage to equipment or damage to the environment.



Risk of fire by igniting flammable material.



Risk of coming into contact with electricity.



Sharp elements. Take care to avoid injury from sharp elements.



Hot surface. Take care to avoid coming into contact with a hot surface.



Closing mechanical parts. Take care to avoid injury to hands when in the vicinity of equipment with closing mechanical parts.



Floor level obstacle. Take care when in the vicinity of a floor level obstacle.



Beware of Electrostatic Discharge (ESD). Electrostatic precautions must be used:

- Switch off the machine.
- Wear a wristband connected to ground.
- Avoid wearing clothing that can build up electrostatic voltages.
- Use ESD protective bags to transport PCBs.
- Only place PCBs on a mat made from a material which will dissipate electrostatic voltages and which is connected to ground.



Eye protection must be worn.



Protective clothing must be worn. Use adequate protective gloves. Consult the relevant Safety Data Sheet (SDS).



Disconnect power before carrying out maintenance or repair.



Connect an earth terminal from the product to an appropriate ground source.



Read the manual before doing this procedure.

SPECIFIC WARNINGS

Handling the Vx-Series Cassette

WARNING

Cassette Handle is Not a Carry Point. Risk of Injury or Equipment Damage.



Do not use the cassette handle to carry or hold the printer.

The printer may become detached from the cassette causing injury or equipment damage. The cassette handle is for removing the cassette only. Use both hands when carrying the printer.

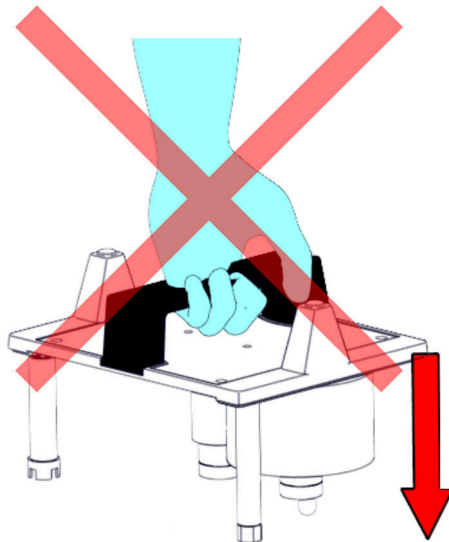

WARNING**Do Not Remove Tape Before Installation. Risk of Injury or Equipment Damage.**

Do not remove the tape marked below by (red) circles, before installation of the printer on the bracket.

The tape helps to prevent the printer becoming detached from the cassette and falling. If the printer falls, it may cause injury or equipment damage.



Replacing the Ribbon

WARNING**Sharp Edges. Risk of Injury.**

Take care when replacing ribbons to avoid sharp edges.

These are very sharp and could cause injury.

Warning: Hot Surface

WARNING**Hot Surface. Risk of Injury.**

Do not touch the heating element area of the print head or the rear cover of the printer body.

These areas can become very hot and could cause injury.

Cleaning Fluids

WARNING**Hazardous Chemicals. Risk of eye and skin damage.**

Wear protective equipment such as gloves and glasses when near the printer.

Contact with chemicals can cause skin or eye damage.

Refer to Safety Data Sheet.

WARNING**Harmful Vapour. Risk of Injury.**

Avoid inhaling cleaning fluid vapour.

Cleaning fluid vapour is harmful.

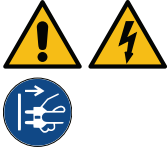
Disconnect Power**WARNING****Electricity. Risk of injury.**

Turn off the equipment and disconnect the power supply before disconnecting or making electrical connections.

When powered on, the controller contains live electrical components. Physical contact with live electrical components can result in an electric shock.

WARNING**Equipment May Start Automatically. Risk of Injury.**

Turn off the equipment and disconnect the power supply before removing any service covers, doing any maintenance or cleaning.

When powered on, the printer may start operation automatically. If the printer starts when not expected, injury may occur.

Crush Hazard**WARNING****Moving Parts. Risk of Injury.**

Keep hands, hair and loose clothing away from the print head opening when the printer is powered on.

The print head may move without warning. If hands, hair or loose clothing are near the print head when it moves, they may be caught by the print head and cause injury.

Obstacle Hazard**WARNING****Obstacle Hazard. Risk of Injury.**

Do not install the printer, cables and accessories in a walkway, or in a location where they may cause an obstacle hazard.

If the printer, cables and accessories are installed in a walkway, or in location where they may cause an obstacle hazard, injury to personnel may occur.

Water Hazard

WARNING Water is an Electrical Conductor. Risk of Injury.	
	<p>Do not touch the equipment with wet or damp hands. Do not expose the equipment to water.</p> <p>The equipment contains live electrical components. If the equipment comes into contact with water, electricity may be conducted to personnel and cause injury.</p>

Disclaimer

The information above is correct to the best of our knowledge, information and belief at the date of this publication. The information given is designed only as guidance for safe handling, use, processing, storage, transportation, disposal and release and is not considered a warranty or quality specification. The information relates only to the specific material designated and may not be valid for such material used in combination with any other materials or in any process unless specified in the text.

SPECIFIC CAUTIONS

Consumables and Spares

CAUTION Non Genuine Consumables and Spares are Not Guaranteed. Risk of equipment damage.	
	<p>Only use genuine Domino ribbons, cleaning materials, print heads and spare parts.</p> <p>Use of non genuine consumables and spare parts may cause equipment damage.</p>

Cleaning Material for the Print Head

CAUTION Sensitive Parts. Risk of equipment damage.	
	<p>Abrasive materials, lint producing materials, metal tools, high pressure air and de-greasing fluids may damage the print head.</p> <p>To clean the print head, only use soft brushed and lint free cloths.</p> <p>Always use Domino Cleaning pens (VPR0223), cleaning fluid (WJ-111).and cleaning wipes (EPT039697).</p> <p>Do not use abrasive materials, lint producing materials, metal tools, high pressure air or de-greasing fluids.</p>

Damage to Print Head

CAUTION Printing Without Ribbon. Risk of equipment damage.	
	<p>Do not attempt to print without a ribbon.</p> <p>Make sure ribbon is in the printer before attempting to print.</p> <p>Printing without ribbon installed may damage the print head.</p>

Loss of Counter Data

CAUTION Printer Shut Down. Risk of data loss.	
	<p>If label counter values need to be retained, do not turn off/shut down the printer.</p> <p>If the printer is turned off, label counter values may be lost.</p>

Cable Routing

CAUTION Bad Cable Routing. Risk of equipment damage.	
	<p>Route cables and wires away from moving parts and machinery. Make sure that cables and wires are properly secured, so they are not at risk of being caught in moving parts or machinery.</p> <p>If cables and wires become caught in moving parts or machinery, damage to equipment may be caused.</p>

Covers

CAUTION Do not operate with any covers removed. Risk of equipment damage.	
	<p>When operating the printer, make sure that all covers are fitted using the correct number of fasteners.</p> <p>The covers protect the printer's internal components against dust, dirt and static electricity damage.</p>

Mains Electrical Supply Voltage

CAUTION Wrong electrical supply voltage. Risk of equipment damage.	
	<p>If the electrical supply voltage to the equipment exceeds the values stated in this manual, the equipment may become damaged.</p> <p>Do not exceed the electrical supply voltage stated in this manual.</p>

CONSUMABLES INFORMATION

Domino supplies Safety Data Sheets (SDS) giving specific safety information for each of its ribbons and solvents. Safety Data Sheets can be found on the MSDS section of the Domino website.

- Read the Safety Data Sheet (SDS) for Cleaning Fluid (P/N WJ-111) before using it with any Domino product.
- Any used cleaning materials, e.g. rags, paper wipes, are a potential fire hazard. They must be collected for safe disposal after use.

Fire Risk

Obey all warnings given on the machine and the following safety instructions.

For an electrical fire, do not use water.

Fire risk is a most important consideration where printing ribbons are stored and used. The degree of fire hazard will vary considerably from one type of ribbon to another. The ribbons used by Vx-Series printers are not flammable.

When there is a particular hazard the appropriate information is given on the SDS.

If there is a fire, there is a likelihood that dangerous fumes will arise from printing ribbons. For this reason ribbons must be stored where they can be reached quickly by the fire fighting service, and where fire will not spread beyond the store.

Disposal

Waste printing material and ribbon must not be treated as ordinary waste. Dispose of them using approved methods that obey local regulations.

ELECTRO-STATIC DISCHARGE

To avoid static discharge from production line equipment, the equipment and everything on it must be grounded correctly. While it is not Domino's responsibility to maintain the customer's equipment, the customer must be aware of the importance of grounding. At the time of installation of the printer, the Domino (or Domino distributor) technician should ensure that the line the printer is installed on is appropriately grounded. This means that all metallic items within 12 inches (300mm) of the print head location must be securely grounded. This should be checked with respect to the print head chassis ground using an Ohm Meter, DVM or another suitable device. It is essential that grounding is checked periodically and that if the printer is relocated to a different production line, then the new production line is properly grounded. Additional static dissipating devices, such as static brushes on the line, etc. are recommended.

PRODUCT/BATTERY END OF LIFE

WARNING		Flammable material. Risk of fire or explosion.
	Do not dispose of the battery in a fire, hot oven, by mechanically crushing or cutting.	
	Obey local waste regulations when disposing of batteries.	
	Do not store or leave the battery in high or low extremes of temperature.	
		Do not store or leave the battery in a location that is subject to low air pressure at high altitudes.

CAUTION		Hazardous Material. Risk of damage to equipment and environment.
	The battery is not removable. If the battery needs replacement, replace the PCB that the battery is installed on. Obey local waste regulations when disposing of the battery and PCB.	

Recycling information in accordance with the WEEE and Battery Directives



Product Mark



Battery Mark

European Union Only

The product/battery is marked with one of the above recycling symbols. It indicates that at the end of life the product/battery, you should dispose of it separately at an appropriate collection point and not place it in the normal domestic waste stream.

USA STATE OF CALIFORNIA BATTERY STATEMENT

Perchlorate Material - special handling may apply.

See www.dtsc.ca.gov/hazardouswaste/perchlorate

PART 2 SYSTEM DESCRIPTION

DESCRIPTION

The Domino Vx-Series is a range of Thermal Transfer Overprint printers intended for printing fixed and variable data on products on manufacturing production lines. For specific details, contact your local support office.

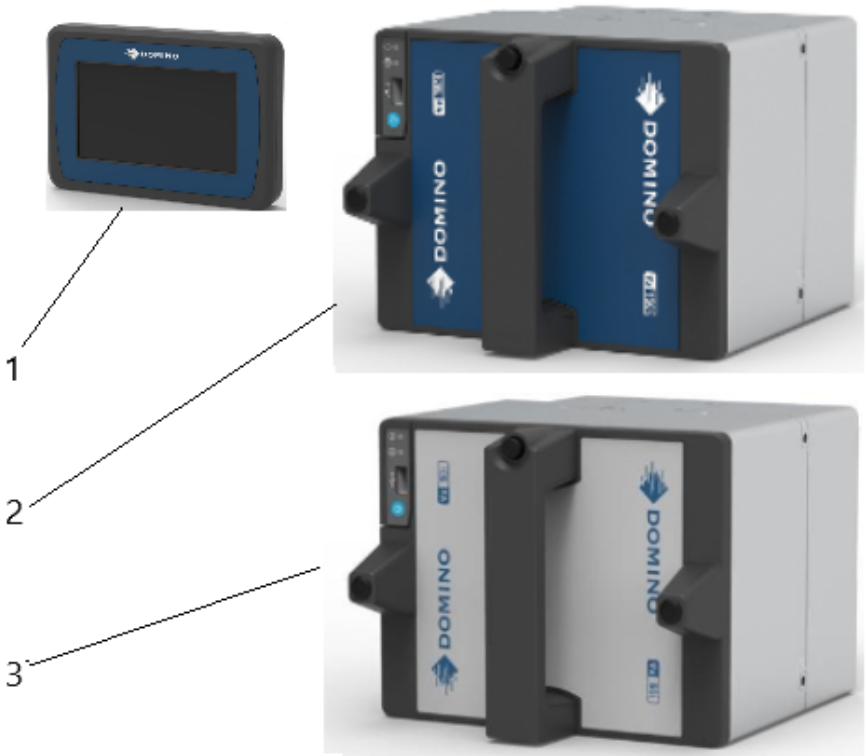

Each Vx-Series consists of:

1	Display	See Display on page 26 .
2	Vx150i Printer. The printer contains the electronic control systems and ink ribbon system.	See Printer Vx150i and Vx50i on page 21 .
3	Vx50i Printer. The printer contains the electronic control systems and the ink ribbon system.	See Printer Vx150i and Vx50i on page 21 .

The Vx-Series printers are the latest in high resolution Thermal Transfer Overprint printers capable of printing multiple lines of text, graphics, various machine readable codes (Barcodes and 2D codes), counters and time/date functions, all from its stand-alone unit.

PRINTER TYPES

The Vx -Series printers are sold in six types:

Printer	Print Head	Ribbon Widths	Handedness	Part Number
Vx150i	53 mm	55 mm and 34 mm	Right	8D3214001DU
			Left	8D3213001DU
	32 mm	34 mm and 22 mm	Right	8D3216001DU
			Left	8D3215001DU
Vx50i	32 mm	34 mm and 22 mm	Right	8D3212001DU
			Left	8D3211001DU

- Notes
1. A Left Hand printer can be converted to Right Hand (and vice-versa). Consult Domino.
 2. It is not possible to convert a Vx50i printer to a Vx150i printer (or vice-versa).

SPECIFICATION

Printer Vx150i and Vx50i

Physical

Item	Details
Standard Finish:	Anodised Aluminium
Dimensions:	Height: 160 mm Width: 200 mm Depth: 218 mm
Weight:	5.85 kg
Electrical Supply (rated):	24 V DC, 5.8 A, 139.2 Watts

Environmental

Item	Details
Location:	Indoor
Operating Temperature:	5 °C to 40 °C (41 °F to 104 °F)
Storage Temperature:	-20 °C to 60 °C (-4 °F to 140 °F)
Operating Relative Humidity:	10 - 90% RH (Non-Condensing 10 °C Increase per hour)
Pollution Degree:	(2)
Altitude:	2000 metres max.

Display



Physical



Item	Details
Display:	7 inch, touch sensitive
Dimensions:	Height: 150mm Width: 220mm Depth: 30mm
Weight:	0.6 kg
Mounting:	VESA 75mm x 75mm on rear face, using 4off M5 x 5.5mm deep holes.

Environmental

Item	Details
Location:	Indoor
Operating Temperature:	5 °C to 40 °C (32 °F to 104 °F)
Storage Temperature:	-20 °C to 60 °C (-4 °F to 140 °F)
Operating Relative Humidity:	20 - 80% RH (Non-Condensing 10 °C Increase per hour)
Altitude:	2000 metres maximum
IP Rating:	IP4X

PART 3 INSTALLATION

MECHANICAL INSTALLATION

WARNING Industrial Equipment. Risk of Injury	
 	Mechanical installation must be done by a suitably trained and qualified person.

Unpacking

Remove the printer and accessories from the packaging.

The equipment delivered will vary according to the specific order. Check the contents of the shipment against the packing list and report any discrepancies to Domino immediately.

Location

Position the printer and display:

- Where they are electrically isolated from other equipment.
- Where the temperature remains within the specified range, see [Environmental on page 21](#).
- Where the relative humidity remains within the specified range, see [Environmental on page 21](#).
- Close to an accessible electrical power outlet, to make sure that electrical power can be disconnected quickly.

Display

The display can be mounted on a stand or fixed to a vertical surface.

It has 4 off M5 x 5.5mm deep tapped holes to accept a 75mm x 75mm VESA bracket.

Printer Mechanical Drawing

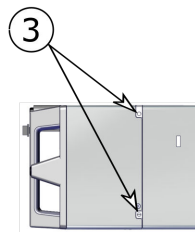
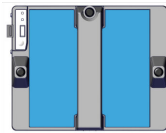
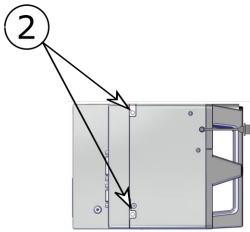
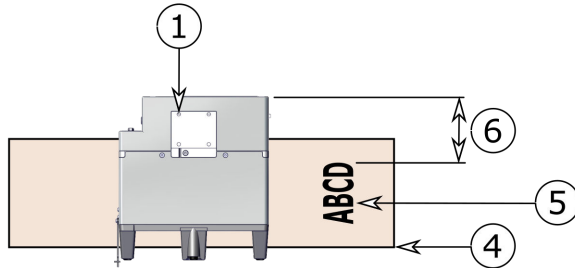
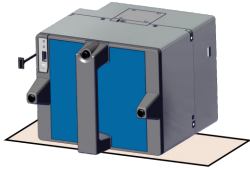

Details	
1	4 off M6 x 9.5mm on top of printer
2	2 off M6 x 6mm on left side of printer
3	2 off M6 x 6mm on right side of printer
4	Substrate
5	Printing on substrate
6	104.525 mm Minimum distance between printing on the substrate and the back of the printer.

ELECTRICAL INSTALLATION

WARNING	High voltage electricity. Risk of death or injury from electric shock.
	Electrical installation must be done by a suitably trained and qualified person.

Only use Domino supplied cables to connect the Display and Printer.

Only use the Domino supplied Power Supply Unit (PSU).

The PSU must be connected to the mains output socket using a removable plug. This is to allow electrical isolation of the printer, when required. The mains power outlet socket must be installed near the printer in an easily accessible position.

There is a danger of electric shock from the electric shock from the electrical outlet. All electrical checks must be performed by qualified personnel.

Display

The display connects to the base unit by a single cable.

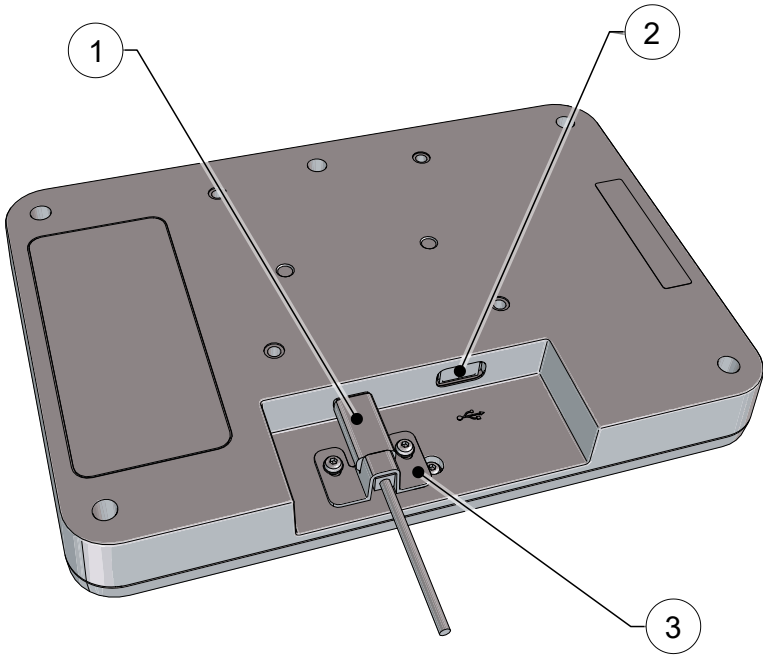

1	Connection to base unit
2	USB connector
3	Retaining clip

Printer Connections

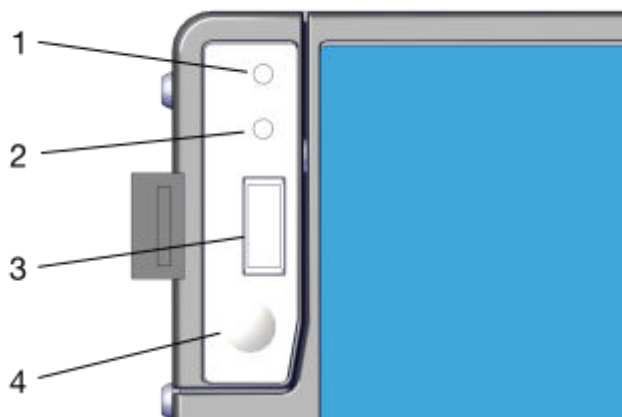

Front	Name	Details
1	Status LED	Status LED
2	Print Detect LED	Print Detect LED on page 30
3	USB1	1.5 A
4	Power button	

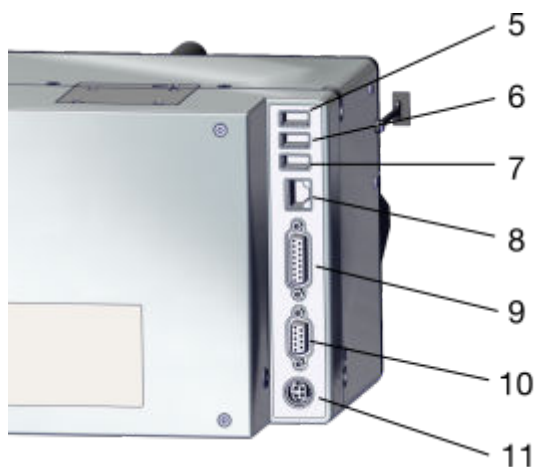

Rear	Name	Details
5	USB2	1.5 A
6	USB3	1.0 A (not suitable for powering the WiFi dongle or display)
7	USB4	0.5 A (not suitable for powering the WiFi dongle or display)
8	LAN	RJ-45 Ethernet
9	I/O Connector	D-Sub, 15-Way, Female
10	Encoder Connector	D-Sub, 9-Way, Female
11	DC	Power DIN 4 pin

PART 4 OPERATION

START UP

To start up the printer:

1. Connect the printer to a power supply and wait for the Status LED to turn white. Turn on the printer using the Power Button. (Item 3 below).



1	Status LED
2	Print Detect LED
3	Power Button

Status LED

Action	Status	LED Colour
Plug power supply into mains outlet.	Booting up system	Off
	Booting up system	Red
	Ready to power on	White
Press power button	Booting up controller application	Red flashing
	Calibration	Amber
	Idle	Blue
Press START	Ready	Green

LED Colour	Description
Purple flashing	Printer failed to start.
Amber	The printer has detected an amber alert.
Red	The printer has detected a red alert.

Print Detect LED

LED Colour	Description
White	Print Detect Signal is connected directly to the Print Detect LED (Hence there is no delay).

Note The Print Detect LED can be switched off using the check box at Setup > Settings > Production line setup > Print trigger > Print detect LED.

Auto Start-Up Mode

Home > Setup > Settings > Printer configuration > Power options > Auto start-up mode (tick box)

When this mode is selected, the printer will automatically initialize when power is applied.

There is no need to press the *POWER* button.

When the printer is plugged in, the "ready to power on" status is skipped and the controller application boots up.

When the printer is turned off using the power switch, the printer will:

- Shut down
- Boot up automatically.



This is similar to restarting the printer.

Assign a Label

To assign a label for printing:

1. Select *Home* > *Label manager* > *Open*.
2. If the label name or part of the label name is known, select *Filter labels...* and enter the label's name. If the label name is not known, swipe the screen vertically to scroll through the available labels.

Note Stored labels can be viewed by name, or by name and a preview image.

	View labels by name.
	View labels by name and preview image.
	Refresh the label list.

3. When the required label has been found, select the send to print icon:



Load last label on start-up

Home > *Setup* > *Settings* > *Printer configuration* > *Power options* > *Load last label on start-up* (tick box)

When this mode is selected, the last label to be used will be loaded when the printer starts-up.

Start Printing

To start printing:

1. Select *START* at the top of the user interface.

Stop Printing

To stop printing:

1. Select *STOP* at the top of the user interface.

STATUSES, ALERTS AND FAULT FINDING

Statuses

Shown below are some printer statuses and their explanations. Printer statuses are displayed on the Status tab at the top of the QuickStep interface.

Status	Status Tab Colour	Explanation
Idle	Grey	The printer is not active.
Ready	Green	The printer is ready to print.

Alerts

Alerts are displayed on the Status tab at the top of the QuickStep interface. When multiple alerts occur, only the highest alert will be displayed. If multiple alerts occur, the full list of alerts can be viewed by selecting the status tab.

There are two different alert levels:

Alert Level	Status Tab Colour	Explanation
Alarm	Red	There is a serious problem with the printer. Printing may stop until the alert is cleared.
Warning	Amber	There is a problem with the printer but printing will continue.

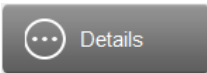

To clear an alert or view information about how to solve the alert:

1. Select the *Status* tab.
2. The icons illustrated below will become available to select.

Icon	Explanation
	Select the <i>Details</i> icon to display the following information: <ul style="list-style-type: none">• Date and time the alert occurred.• Alert ID number.• Alert level.• Detailed information about the alert.• A clear button to acknowledge and clear the alert.

PART 5 MAINTENANCE & TROUBLESHOOTING

INSTALL A RIBBON

WARNING Sharp Edges. Risk of Injury.	
 	<p>Take care when replacing ribbons to avoid sharp edges.</p> <p>These are very sharp and could cause injury.</p>

An amber alert on user interface will indicate that the ink ribbon needs replacing.

A red alert on the user interface will indicate that the printer is out of ribbon and will stop.

-
- | | |
|-------|---|
| Notes | <ol style="list-style-type: none">1. To ensure good quality print, always clean the print head before fitting a new ribbon to the printer.2. When fitting a new ribbon, ensure loose ribbon is wound up on the take-up spool to create tension in the ribbon path. If this is not done, the ribbon will not be fed correctly around the guides and rollers in the ribbon path. This will result in poor or no printing.3. When inserting the cassette in the printer, ensure that the ribbon fits between the printer's guide roller and print head within the printer. If this is not achieved, it may result in poor quality print and ribbon breaks. |
|-------|---|
-

Printer Handedness

The printer may be either Left-Handed or Right-Handed.

The images below identify the two types of printer and how to thread the ribbon in the cassette.

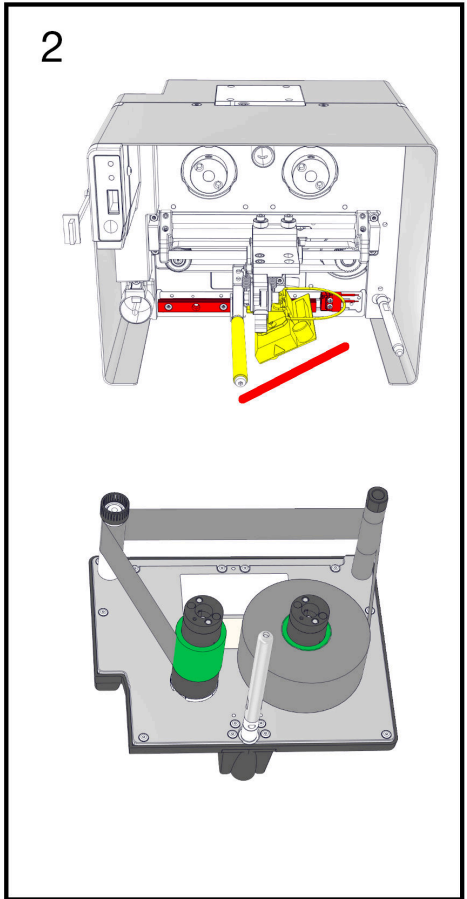
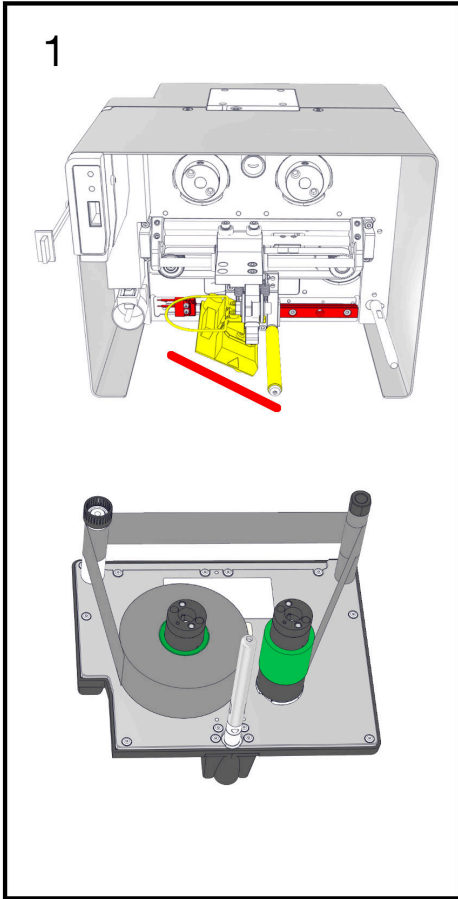

1	Left-Handed Printer	2	Right-Handed Printer
---	---------------------	---	----------------------

Ribbon Threading Procedure

Vx-Series Left-hand printer:

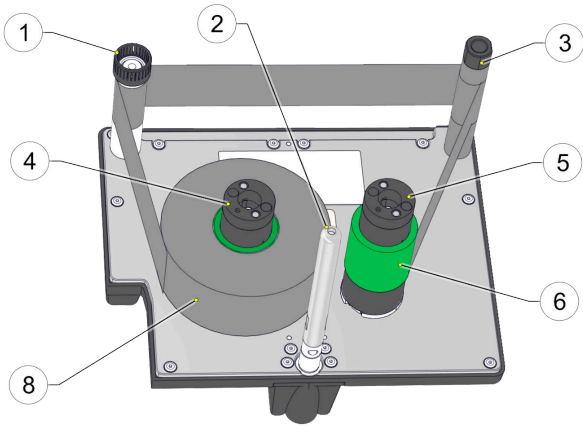

Vx-Series Right-hand printer:

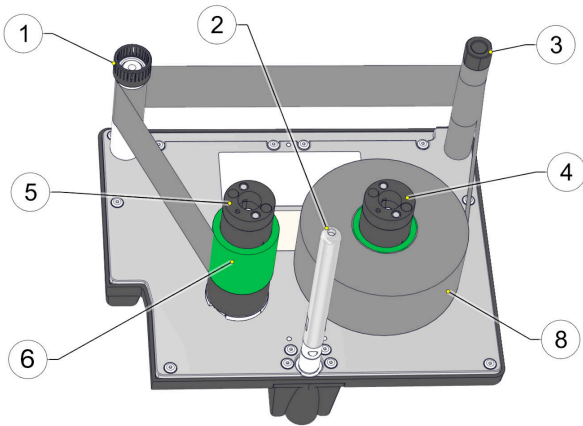

#	Description
1	Internal ribbon encoder roller
2	Lock shaft
3	Free roller
4	Unwind spindle

#	Description
5	Rewind spindle
6	Note Ribbon on green cores
7	Spacer (one on each spindle) Note Check tables below for the correct spacer thickness.
8	Note Ink on outside of ribbon (Ink-out ribbon)

Note The Vx-Series printers use ribbon rolls with the ink on the outside (green core). Do not use V-Series rolls with the ink on the inside (blue core).

Remove the cassette from the printer

1. Press the unlock button on the cassette and gently pull the printer's front cover straight out towards you to remove it.

Note The printer will be set up as either a right-hand printer or a left-hand printer. Referring to the ribbon path diagram labels on the printer cover or in the diagrams above, determines if the printer is set up for left-hand or right-hand printing.

Some combinations of printer and ribbon widths require spacers.

Vx150i with 53 mm Print Head		
Ribbon	Spacer	Description
55 mm	None needed	
34 mm		Black. 4 mm thick (10 mm overall)
22 mm	Configuration not possible	

Vx150i with 32 mm Print Head Vx50i with 32 mm Print Head		
Ribbon	Spacer	Description

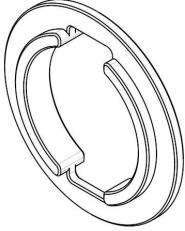
Vx150i with 32 mm Print Head		
Vx50i with 32 mm Print Head		
55 mm	Configuration not possible	
34 mm	None needed	
22 mm		White. 2 mm thick (6 mm overall)

Note The spacers are accessories. See the Vx-Series Accessories Catalogue.

Fit the new ribbon

Note Images show a left-hand printer.

1. Identify the unwind spindle.
2. Fit spacers on both spindles (only if required). See tables above for required spacers:
3. Lift the unwind spindle away from the base plate to disengage the spring clips.

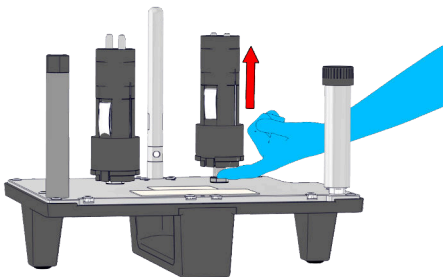

4. Fit a ribbon to the spindle.
5. Press the ribbon core down to engage the spring clips.

-
- Notes
1. It requires a very firm push to engage the spring clips.
 2. Image shows left-hand printer.
-

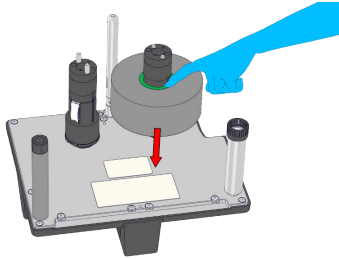

Fit the new re-wind core

1. Identify the rewind spindle.
2. Lift the rewind spindle away from the base plate to disengage the spring clips.
3. Fit an empty rewind core to the spindle.
4. Press the rewind core down to engage the spring clips.

Note It requires a very firm push to engage the spring clips.

Thread the ribbon

1. Pass the ribbon around the free roller and encoder shaft.
2. Wrap the ribbon around the empty ribbon core several times, taking up any slack in the ribbon path to complete the operation.

-
- Notes
1. The ink is on the outside of the ribbon.
 2. Image shows left-hand printer.
-

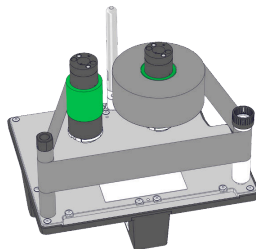

3. Fit the cover.

Note Make sure that the ribbon passes through the gap between the print head and the peel-off roller:

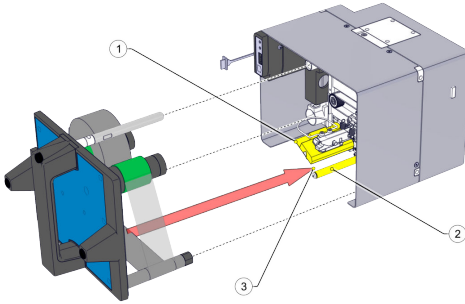



#	Description
1	Print head
2	Peel-off roller
3	Gap

The printer will initialise.

CLEANING

Print Head Cleaning

WARNING		Hazardous Chemicals. Risk of eye and skin damage.
  	<p>Wear protective equipment such as gloves and glasses when near the printer.</p> <p>Contact with chemicals can cause skin or eye damage.</p> <p>Refer to Safety Data Sheet.</p>	

- Notes
1. Always clean the print head after replacing it or a ribbon.
 2. The peel roller, free roller and encoder roller should also be cleaned regularly.

For cleaning, always use these parts:

- Cleaning Pens (P/N VPR0223)
- Cleaning Fluid (P/N WJ-111)
- Print Head Cleaning Wipes (EPT039697)

Some of the dots on the print head can get damaged during use. Overheated dots can result in disintegration of the ceramic material as shown in the picture on the below. Follow the instructions below to prevent this and prolong print head life.

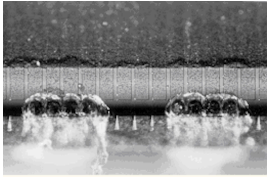



Damaged Print Head

During the printing operation the print head temperature will be increased, and label debris, adhesive and scraps of paper will melt and clog the surface and the corners of the print head. A dirty print head will result in poor print quality or can even result in total print head destruction. Move the cleaning pen from side to side over the print head to clean the head.

Note Do not try to solve the problem of poor quality print by increasing the contrast settings.

Roller Cleaning

WARNING Hazardous Chemicals. Risk of eye and skin damage.	
  	<p>Wear protective equipment such as gloves and glasses when near the printer.</p> <p>Contact with chemicals can cause skin or eye damage.</p> <p>Refer to Safety Data Sheet.</p>

When changing the ribbon and the cassette is removed from the printer, check the cleanliness of:

- The Free roller
- The Encoder roller
- The Peel-off roller
- The Internal Ribbon

For cleaning, always use these parts:

- Cleaning Pens (P/N VPR0223)
- Cleaning Fluid (P/N WJ-111)
- Print Head Cleaning Wipes (EPT039697)



Domino Vx-Series User Guide

Domino Printing Sciences plc has a policy of continuous product improvement, the Company therefore reserves the right to modify the specification contained within this document without notice.

© Domino Printing Sciences plc 2022. All rights reserved.



For additional documentation, including other available languages, either scan the QR code, or go to <https://mydomino.domino-printing.com>

Domino UK Limited

Trafalgar Way
Bar Hill
Cambridge CB23 8TU
United Kingdom

Tel: +44 (0)1954 782551
Fax: +44 (0)1954 782874
Email: enquiries@domino-uk.com

Domino Amjet Inc.

1290 Lakeside Drive
Gurnee IL.60031
U.S.A.

Tel: +1 847 244 2501
Fax: +1 847 244 1421
Email: solutions@domino-na.com